











- Refrigerators
- Freezer
- Cooling units
- Water heaters
- Toilets
- Sanisplits
- Bidet
- Macerators
- Waste tanks
- Faucets
- Showers
- Solenoid valves

PORTABLE REFRIGERATORS FOR BOATS AND YACHTS

Portable boat refrigerators are the ideal choice when you need a convenient, quick, and adaptable solution. They are typically chosen for use on small to medium-sized vessels. Portable refrigerators are directly connected to the boat's electrical system and can be used as needed, thanks to their easy portability. They occupy minimal space and still ensure excellent efficiency and high performance. Vitrifrigo's portable fridge-freezers for boating offer low power consumption, quiet operation, and a rapid cooling capability. They are available in 12/24/110 and 220V, with capacities ranging from 16 to 65 liters.



VF35P



VF55P



C65D

REFRIGERATORS - FREEZERS VFREE SERIES

Model	Capacity lt	Dimensions (HxLxD) mm	Weight kg	Voltage	Consumption (24h)	Operating temperature	Energy rating	Code
VF35P	35	440x680x410	19,5	12/24V DC 100/240V AC	55W	+10°C -22°C	D	RE 88150
VF45P	45	490x680x410	20,5	12/24V DC 100/240V AC	55W	+10°C -22°C	D	RE 88151
VF55P	55	500x700x455	22	12/24V DC 100/240V AC	55W	+10°C -22°C	C	RE 88152
VF65P	65	560x710x455	23	12/24V DC 100/240V AC	55W	+10°C -22°C	C	RE 88153



Control panel



Removable cover



Internal LED light



Removable basket



Dual power
(12/24Vdc - 100/240Vac)

PORTABLE REFRIGERATORS

Model	Capacity lt	Dimensions (HxLxD) mm	Weight kg	Voltage	Consumption (24h)	Operating temperature	Energy rating	Code
C29D	29	390x530x345	15	12/24V DC	48W	+10°C -15°C	-	RE 88154
C65D	65	458x765x510	24	12/24V DC	45W	+10°C -20°C	-	RE 88155
C65L	65	458x765x510	24	12/24V DC	45W	+10°C -20°C	-	RE 88156



C130L CHR



C51i CHR

CHROMELOCK REFRIGERATORS - FREEZERS

Single door in black and external unit.



Remotable cooling unit

Model	Capacity lt	Dimensions (HxLxD) mm	Weight kg	Voltage	Consumption (24h)	Operating temperature	Energy rating	Code
C42L CHR	42	532x380x384	15	12/24V DC	31W	-	-	RE 88157
C75L CHR	75	622x470x460	19	12/24V DC	40W	-	-	RE 88158
C130L CHR	130	767x525x565	25	12/24V DC	45W	-	-	RE 88159

Single door in black and internal unit.

Model	Capacity lt	Dimensions (HxLxD) mm	Weight kg	Voltage	Consumption (24h)	Operating temperature	Energy rating	Code
C51i CHR	51	532x380x514	16	12/24V DC	40W	-	-	RE 88160
C90i CHR	90	622x470x547	20	12/24V DC	45W	-	-	RE 88161
C115i CHR	115	766x525x560	21	12/24V DC	45W	-	-	RE 88162



C90X OXC2



C90X OXC2



C130LX OXC2



C51DWI



C75DWL

NAUTICAL FRIDGE FREEZER: ITALIAN DESIGN AND HIGH PERFORMANCE FOR YOUR BOAT

Vitrifrigo marine freezer refrigerators are an essential element that should not be missing on any respectable boat. Designed and entirely made in Italy, Vitrifrigo marine freezer refrigerators offer a compelling alternative for those who desire a product with a modern design and high performance for their boat.

The extensive and comprehensive Vitrifrigo range can meet all consumer needs, with our models available in both freezer refrigerator (standard) and refrigerator-only versions, with total volumes ranging from 25 to 230 liters.

FRIDGE-FREEZER, STAINLESS STEEL, WITH INTERNAL UNIT

Model	Capacity lt	Dimensions (HxLxD) mm	Weight kg	Voltage	Consumption (24h)	Operating temperature	Energy rating	Code
C51X OXC2	51	545x443x515	20	12/24V DC	40W	-	-	RE 88163
C62X OXC2	62	545x513x540	22	12/24V DC	40W	-	-	RE88164
C85X OXC2	85	805x548x462	29	12/24V DC	45W	-	-	RE 88165
C90X OXC2	90	635x533x543	27	12/24V DC	45W	-	-	RE 88166
C5115X OXC2	115	780x588x558	32	12/24V DC	45W	-	-	RE 88167

FRIDGE-FREEZER, STAINLESS STEEL, WITH EXTERNAL UNIT

Model	Capacity lt	Dimensions (HxLxD) mm	Weight kg	Voltage	Consumption (24h)	Operating temperature	Energy rating	Code
C42LX OXC2	42	545x443x380	18	12/24V DC	31W	-	-	RE 88168
C75LX OXC2	75	635x533x456	25	12/24V DC	40W	-	-	RE 88169
C130LX OXC2	130	780x588x558	33	12/24V DC	45W	-	-	RE 88170



Internal LED light system



Integrated Vent Position

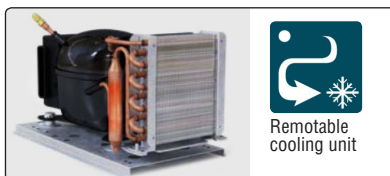

Removable cooling unit



Optional Dual electronic control

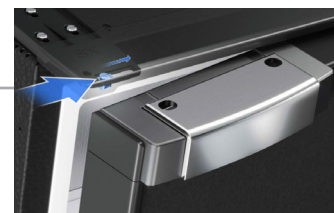

THE NEW CHROMELOCK HANDLE

- elegant metal finish tested for over 150,000 opening and closing cycles
- carries out a positive and safe closing of the door
- integrated "vent position"

FRIDGE-FREEZER, CHROMELOCK DRAWER

Chromelock is the evolution of a high-profile design and production experience, able to combine technological innovation and design, with the functionality and quality of Made in Italy, in the search for a unique style that successfully combines essential elegance, quality value and unique personality.

Model	Capacity lt	Dimensions (HxLxD) mm	Weight kg	Voltage	Consumption (24h)	Operating temperature	Energy rating	Code
C42DWL	42	532x380x384	18	12/24V DC	31W	-	-	RE 88171
C51DWI	51	532x380x514	19	12/24V DC	40W	-	-	RE 88172
C75DWL	75	622x470x460	22	12/24V DC	40W	-	-	RE 88173
C90DWI	90	622x470x547	24	12/24V DC	45W	-	-	RE 88174



Removable cooling unit

TELESCOPIC GANGWAYS

EXO

Hydraulic gangway, telescopic with AISI 316 tubular steel structure at circular section. The stanchions that open out automatically are interchangeable, left/right. Footboards in Burma Teak. Hydraulic box with electrovalves. Polished structure. Control panel on the wall. Remote control included. Functions as a davit and can rotate for operations with the tender. For an easy installation, the piston can be mounted in eight different inclinations.

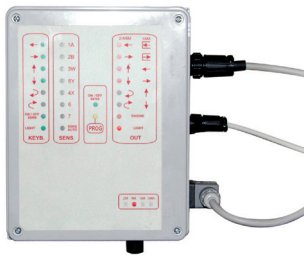

EXO

Model	Length closing	Max extension	Power	Max capacity	Weight Kg	Code
EXO-20	1208 mm	2000 mm	12 V	200 Kg	60 Kg	RE 98001
EXO-23	1363 mm	2300 mm	12 V	200 Kg	64 Kg	RE 98002
EXO-27	1578 mm	2700 mm	12 V	200 Kg	71 Kg	RE 98003
EXO-30	1735 mm	3000 mm	12 V	150 Kg	75 Kg	RE 98004
EXO-20	1208 mm	2000 mm	24 V	200 Kg	60 Kg	RE 98005
EXO-23	1363 mm	2300 mm	24 V	200 Kg	64 Kg	RE 98006
EXO-27	1578 mm	2700 mm	24 V	200 Kg	71 Kg	RE 98007
EXO-30	1735 mm	3000 mm	24 V	150 Kg	75 Kg	RE 98008

Remote control

RE 98000



ICE MAKER

In stainless steel.
Fully automatic (internal 4lt tank).
It can be connected to an external supply for a better range.
Spray system for perfect ice cubes.
Cooling unit R404A (0.140Kg).
CE-IMQ Certifications.

ICEDRINK WHITE LOW PROFILE



Model	Volume	Voltage	Absorption	Dimensions mm	Weight	Code
ICEDRINK CLEAR	4 lt	230V AC	320 W	584x355x430	29 Kg	RE 88053
ICEDRINK WHITE/WHITE DOOR	12 lt	230V AC	180 W	630x355x420	26 Kg	RE 88014
ICEDRINK WHITE INOX	12 lt	230V AC	180 W	630x375x460	27 Kg	RE 88015
ICEDRINK WHITE LOW PROFILE	12 lt	230V AC	180 W	475x370x630	26 Kg	RE 88017



“DIVINO” WINE CELLAR

Resistant metal structure.
No need of ventilation grills.
Maximum capacity obtained by removing the wooden bars.
Double closing system.
Compressor CFC free.
Internal Light.

Model	Supply range V	Bottles capacity N°	Wooden bars	Dimensions HxWxD mm	Weight Kg	Temperature	Code
WC 23	230	27	3	462 x 588 x 538	30,5	Mono	RE 88006
WC 35	230	45	5	715 x 588 x 544	32,5	Mono	RE 88008



“DIVINO” THE ONE

Divino The One is an integrated wine cooler that keeps wine perfectly chilled during service. It's extremely simple to use: just touch any part of the crown with your finger to activate your Divino The One. Touch and serve your wine always at the right temperature.

Power supply	Bottle capacity	Max consumption	Max power usage	Dimensions mm	Weight Kg	Code
12V DC	3	7A	75W	Ø 152 x 30	2	RE 88052

TRAVEL BOX REFRIGERATORS



TB 13

TB 18

TRAVEL BOX REFRIGERATOR ISOTHERM

Isotherm travel boxes offer great capacities to store food and drinks on board. Their compact and light design helps to optimise space on board.

Model	Volume liter	Dimensions mm	Weight kg	Supply V	Consump. (24h)	Operating temperature °C	Energy class	Code
TB 13	13	360x225x535	8,5	12/24V DC	150	from +10 to -18	A+	RE 88022
TB 18	18	405x235x565	9	12/24V DC	150	from +10 to -18	A+++	RE 88023



BI 36

BI 30

BI 16

BUILT IN FREEZER

The BI refrigerators models box equipped with the space saving Secop BD 1.4F Micro compressor solution. The upper lids with inner recess allows big bottle storage. Temperature range from 0°C to +10°C. They combines great usability to high development standards, thanks to they easy to use digital display and to a "splash proof" IPX5 front protection.

Model	Volume liter	Dimensions mm	Supply V	Consump. (24h)	Operating temperature °C	Code
BI16	16	557x384x240	12/24	155	from 0° to +10°	RE 88058
BI30	30	724x448x251	12/24	265	from 0° to +10°	RE 88059
BI36	36	685x438x240	12/24	290	from 0° to +10°	RE 88060



BUILT IN REFRIGERATOR BI 29 DUAL

Indel Webasto Marine Built-In boxes allow an optimised use of space on board thanks to the top-loading access to the interior. They are extremely flexible in size and design.

Model	Voltage supply V	Internal volume lt	Dimensions (HxWxD) mm	Weight Kg	Operating temperature °C	Max energy consumption (24h)	Code
BI 29	12-24	29	370x342x505	18	from +10 to -12	250 W	RE 88029



BUILT IN REFRIGERATOR BI 41 DUAL

Stainless steel inner liner, plastic bottom section
One wire basket removable
One insulation with rubber seal for the lid
Fan cooled compressor mounting below
Easily repositioned up to 1,5 m away

Model	Voltage supply V	Volume lt	Dimensions (HxWxD) mm	Weight Kg	Temperature °C	Max power consumption (24h)	Code
BI -41	12-24	41	610 x 497 x 342	19	+10° -10°	270 W	RE 88002



BUILT IN REFRIGERATOR BI 40

Compact and efficient refrigerator
Fan cooled side mounted compressor unit is easily repositioned up to 1,5 m away
One insulation with rubber seal for the lid

Model	Voltage supply V	Volume lt	Dimensions (HxWxD) mm	Weight Kg	Temperature °C	Max power consumption (24h)	Code
BI -40	12-24	40	400 x 395 x 560	16	+10° -2°	270 W	RE 88024

BUILT IN REFRIGERATORS



BUILT IN REFRIGERATOR BI 53 F

Internal coating in steel, bottom in plastic. Removable internal basket
Compressor fixed inside the bottom of the structure
Eventually removable up to 1,5 meters

Model	Voltage supply V	Internal volume lt	Dimensions (HxWxD) mm	Weight Kg	Temperature °C	Max power consumption	Code
BI 53 F	12 - 24	53	630 x 425 x 645	26	0° - 20°	260 W	RE 88035



BUILT IN REFRIGERATOR BI 75

Internal coating in steel, bottom in plastic. Two removable internal baskets
Compressor fixed inside the bottom of the structure
Eventually removable up to 1,5 meters

Model	Voltage supply V	Internal volume lt	Dimensions (HxWxD) mm	Weight Kg	Temperature °C	Max power consumption	Code
BI 75	12 - 24	75	630 x 425 x 645	26	+15° - 20°	340 W	RE 88037



BUILT IN REFRIGERATOR BI 92 DUAL

Internal coating in steel, bottom in plastic. Three removable internal baskets
Compressor fixed inside the bottom of the structure
Eventually removable up to 1,5 meters

Model	Voltage supply V	Internal volume lt	Dimensions (HxWxD) mm	Weight Kg	Temperature °C	Max power consumption	Code
BI 92 DUAL	12 - 24	92	615 x 480 x 801	28	+10° - 20°	360 W	RE 88038



BUILT IN REFRIGERATOR BI 172 DUAL

The Built-In 172 DUAL is a combined cooling solution 130 liter fridge & 38 liter freezer or 172 liter fridge only, capable to work on a multiple use base.

It is a fridge/freezer or a fridge only device to be nicely integrated into a furniture assembly.

The innovative concept at the base of the BI172 product development is modularity both in use

and in application. It is possible to change the product's functions according to the customer needs, since it has been specified to cover all market/customer requirements.

Model	Voltage supply V	Internal volume lt	Dimensions (HxWxD) mm	Weight Kg	Max power consumption	Code
BI 172 DUAL	12/24V DC 220V AC	172l only refrigerator 130l refrigerator + 38l freezer	840x1015x560	45	603 W	RE 88030



CRUISE REFRIGERATORS

DESIGNED FOR NAUTICAL APPLICATION:

Operate noiselessly, be thoroughly reliable and consume a minimum battery power Grey door panels. Door with a safety lock and magnetic rubber seal.

Fan cooled 12/24 Volt danfoss compressor.

The compressor unit is easily removed and can be mounted in any vertical position up to 1,5m.

Provided with a manual thermostat.

Temperature is adjusted by a thermostat which also has an on- off switch.

System 12V: sensor turns off at 10V (it starts at 12V).

System 24V: sensor turns off at 21V (it starts at 24V).

Panel door: standard grey (on request is available white, teak, mahogany, cherry).

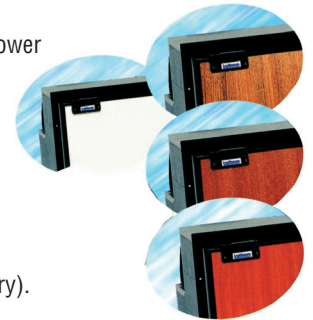

CRUISE CLASSIC

Model	Voltage supply V	Total volume	Capacity freezer lt	Dimensions (HxWxD) mm	Weight Kg	Temperature °C	Max power consumption	Code
Cruise 36	12- 24	36	-	250 x 440 x 715	16	+5° -6°	300 W	RE 88001
Cruise 86	12- 24	86	10	380 x 850 x 495	22	-	5 A	RE 88104
Cruise 100	12- 24	100	6	745 x 485 x 455	26	+5° -6°	4 A	RE 88099
Cruise 130	12- 24	130	8	745 x 525 x 505	27	+5° -6°	5 A	RE 88100

CRUISE ELEGANCE

Model	Voltage supply V	Total volume	Volume freezer lt	Dimensions (HxWxD) mm	Weight Kg	Temperature °C	Max power consumption	Code
Cruise 42	12- 24	42	5	525x380x515 (310)	16	+5° -6°	2,7 A	RE 88003
Cruise 49	12- 24	49	5	525 x 386 x 450	17	+5° -6°	2,7 A	RE 88096
Cruise 65	12- 24	65	5	530 x 450 x 480	18	+5° -6°	2,7 A	RE 88097
Cruise 85	12- 24	85	8	625 x 475 x 515	23	+5° -6°	4 A	RE 88098



DR55 Freezer

DRAWER A CASSETTO INOX

DESIGNED FOR NAUTICAL USE.

New drawer refrigerator with innovative design offers real installation opportunities.

Stainless steel front panel. The DR 160 INOX light model is divided into 2 drawers.

Model	Voltage supply	Capacity frigo	Capacity freezer	Dimensions (W x H x D) mm	Weight Kg	Consumption (Wh/24h)	Code
DR55 Freezer	12/24V DC	-	55 lt	469 x 525 x 555	24	741	RE 88039
DR65 Frost Free	12/24V DC	65 lt	-	469 x 525 x 555	27	310	RE 88040
DR105	12/24V DC	105 lt	-	515 x 515 x 575+170	28	480	RE 88041
DR160 inox light	12/24V DC	90 lt	70 lt	627 x 865 x 610	46	635	RE 88042
DR190	12/24V DC	190 lt	-	900 x 800 x 545	56	700	RE 88043



DR160 inox light



DR105



DR190



DR65

STAINLESS STEEL REFRIGERATORS

DESIGNED FOR NAUTICAL APPLICATION: operate noiselessly, consume a minimum battery power
Stainless steel door totally flush with an integrated door latch
In the front and also interior details have stainless steel trims



CRUISE 36 STEEL REFRIGERATORS

Same as CR36 but in stainless steel
Ideal solution when small spaces are available
Compressor can be moved up to 1m

Model	Voltage supply V	Volume total lt	Volume freezer lt	Dimensions (HxWxD) mm	Weight Kg	Temp. °C	Max power consump.	Code
Cruise 36 Steel	12 - 24	36	-	250x455x715	16	+5° - 6°	2,7 A	RE 88010
Cruise 130 Drink	12 - 24	130	-	560x545x750	28	+5° - 6°	400 W (24h)	RE 88061
Cruise 160 Drink	12 - 24	160	-	610x626x870	40	+5° - 6°	512 W (24h)	RE 88062



STAINLESS STEEL REFRIGERATORS COMBI

Double door. Refrigerator + Freezer

Model	Voltage supply V	Volume total lt	Volume freezer lt	Dimensions (HxWxD) mm	Weight Kg	Temp. °C	Max power consump.	Code
Cruise 195 Steel	12 - 24	130	65	1345x545x580	51	+5° - 18°	6 A	RE 88051
Cruise 220 Steel	12 - 24	130	90	1545x545x560	59	-	6 A	RE 88032
Cruise 260 Steel	12 - 24	130	130	1545x545x560	64	-	6 A	RE 88033
Cruise 320 Steel	12 - 24	160	160	1790x628x610	85	-	6 A	RE 88034



STAINLESS STEEL REFRIGERATORS CLEAN TOUCH

Model	Voltage supply V	Volume total lt	Volume freezer lt	Dimensions (HxWxD) mm	Weight Kg	Temp. °C	Max power consump.	Code
Cruise 42 Steel	12 - 24	37	5	530x400x515 (350)	15	-	2,7A	RE 88012
Cruise 49 Steel	12 - 24	49	5	520x400x510	18	+5° - 6°	2,7 A	RE 88004
Cruise 65 Steel	12 - 24	65	5	530x470x540	21	+5° - 6°	2,5 A	RE 88019
Cruise 85 Steel	12 - 24	85	8	625x495x555	24	+5° - 6°	4 A	RE 88005
Cruise 130 Steel	12 - 24	130	8	743x545x545	27	+5° - 6°	5 A	RE 88007



DR 85

STAINLESS STEEL DRAWER REFRIGERATOR CLEAN TOUCH

DESIGNED FOR NAUTICAL APPLICATION

New design: space saving and front opened. Available in stainless steel front panel.

Model	Voltage supply V	Volume total lt	Volume freezer lt	Dimensions (HxWxD) mm	Weight Kg	Temp. °C	Max power consump.	Code
DR 49 Steel	12 - 24	41	8	520x405x510	24	-	5 A	RE 88020
DR 65 Steel	12 - 24	54	11	526x470x545	28	+5°	5 A	RE 88092
DR 85 Steel	12 - 24	68	17	625x495x545	32	+5°	370 W	RE 88045
DR 100 Steel	12 - 24	105	-	520x520x770 (600)	33	+5°	5 A	RE 88026
DR 130 Steel	12 - 24	114	16	745x545x545	35	+5°	429 W	RE 88046

REFRIGERATOR UNITS



STAINLESS STEEL FREEZER CRUISER

INTERIOR WITH 4 DRAWERS.

The door is flush with a fixing flange and closure is guaranteed by an integrated snap lock. Extra insulation for excellent cooling performance and low energy consumption.

Model	Voltage supply V	Total volume lt	Volume freezer lt	Dimensions (HxWxD) mm	Weight Kg	Operating temperature	Max power consump.	Code
CRUISE 63 F Stainless steel	12-24	63	63	620x495x555	23	+5°-18°	2,7 A	RE 88091
CRUISE 63 Classic	12-24	63	63	620x477x515	22	+5°-18°	2,7A	RE 88047
CRUISE 65 F Stainless steel	12-24	65	-	610x545x580	23	-21°	5 A	RE 88109
CRUISE 65 Classic	12-24	65	65	610x527x540	22	+5°-18°	5 A	RE 88048
CRUISE 90 F Classic	12-24	90	90	745x525x505	29	+5°-18°	2,7 A	RE 88025
CRUISE 90 Classic Clean Touch	12-24	90	90	746x527x520	27	+5°-18°	2,7A	RE 88049

WATER COOLING UNIT

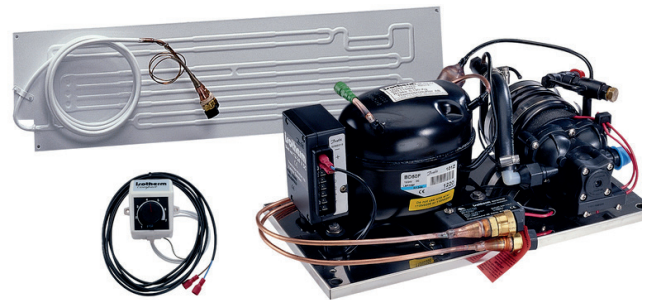

OVAL SHAPE EVAPORATOR

Model	Max Volume fridge/freezer lt	Evaporator dimensions mm	Compressor dimensions mm	Compressor type	Code
2505	20/66	380 x 140 x 270	440 x 220 x 175	BD50F	RE 88055

FLAT SHAPE EVAPORATOR

Model	Max Volume fridge/freezer lt	Evaporator dimensions mm	Compressor dimensions mm	Compressor type	Code
2511	170/56	815 x 210	440 x 220 x 175	BD50F	RE 88056
2512	200/66	1200 x 190	440 x 220 x 175	-	RE 88057

AIR COOLING UNIT

REFRIGERATOR UNITS (OVAL EVAPORATOR)

DANFOSS COMPRESSOR. Absorption compressor: 0.6-2.7A (0.7-4A)
Compact unit regulated of a traditional thermostat
Fan cooled compressor unit designed for simple installation in existing top or side-loaded refrigerator boxes

Model	Volume max lt	Type evaporator	Dimensions evaporator mm	Dimensions compressor mm	Type compressor	Code
GE 80	80/25	Flat	350 x 250	270 x 160 x 155	BD35F	RE 88009
GE 150	150/50	Flat	387 x 361	270 x 160 x 155	BD35F	RE 88013

REFRIGERATOR UNITS (OVAL EVAPORATOR)

DANFOSS COMPRESSOR
Absorption compressor: (small oval 06-2.7A); (medium oval 07-4A); (big oval 0.9-5.2A)
Compact unit regulated of a traditional thermostat
Fan cooled compressor unit designed for simple installation in existing top or side-loaded refrigerator boxes

Model	Volume max lt	Type evaporator	Dimensions evaporator mm	Dimensions compressor mm	Type compressor	Code
2001	125/41	Small oval	240 x 85 x 210	270 x 160 x 155	BD35F	RE 88011
2301	150/50	Medium oval	320 x 100 x 230	270 x 160 x 155	BD35F	RE 88027
2501	200/65	Large oval	380 x 140 x 270	315 x 160 x 155	BD50F	RE 88028

POWER PACK CONVERTER

Necessary to supply the refrigerator with AC current
Voltage supply: 115/230V AC
Able to 12/24V DC bank battery

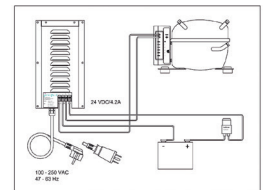

Input voltage AC	Frequency Hz	Input voltage DC	Output voltage DC	Power W	Power A	Dimensions mm	Code
115/230V AC	47 - 63	12 - 24 V	25,5 V	100	4,2	250 x 130 x 43	RE 88016/24

DANFOSS JUNCTION BOX

Easy to replace.
Voltage supply: 12/24V DC. RE 88018

COOLED UNITS ITC DISPLAY MONITOR

The ITC Digital Display can clearly display, control and regulate the temperature in a refrigerated compartment from the exterior of a fridge/freezer cabinet. It is dedicated to people who desire a nice-looking interface, a refined product interaction and to reduce on board power consumption. Remote product interaction is extremely easy and accurate since data readings appear on the display, like temperature set or detected selection of energy saving operations, choice of 3 battery protection levels and compressor's operation mode settings, (ITC, Eco and Overcooling mode). Product integration is simple, since the device is fully compatible with the control unit IWM P/N SEG00002DA (Secop version 101N0212 for BD35/50F), allowing recess flush or wall mounted installation. RE 88050

INSULATED PANELS

Flat pack set of ready-cut insulated panels
The panels are covered on both sides with 3/32" plastic laminate of foodstuff quality. They have 46mm thick closed cell foam insulation in between. Easy to cut and glue together using a polyurethane sealant or mould resistant silicone resulting in joints.
Cover strips for the edges of the lid are included

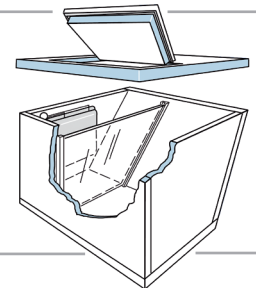

3 insulation panels measuring 978 x 479 x 50mm each RE 88021

STAINLESS STEEL BOILERS



NAUTIC BOILER BX

The tank is made of 1,5 mm gauge 316 Aisi stainless steel. Casing in 304 Aisi stainless steel. The electrical heating element is made of incoloy steel 220V or 115V (on request). Resistant to galvanic corrosion. Heat exchanger with wide exchange surface. The thermal insulation is high density polyurethane foam. Provided with relief/non return valve.
INSTALLATION: Vertical or horizontal.

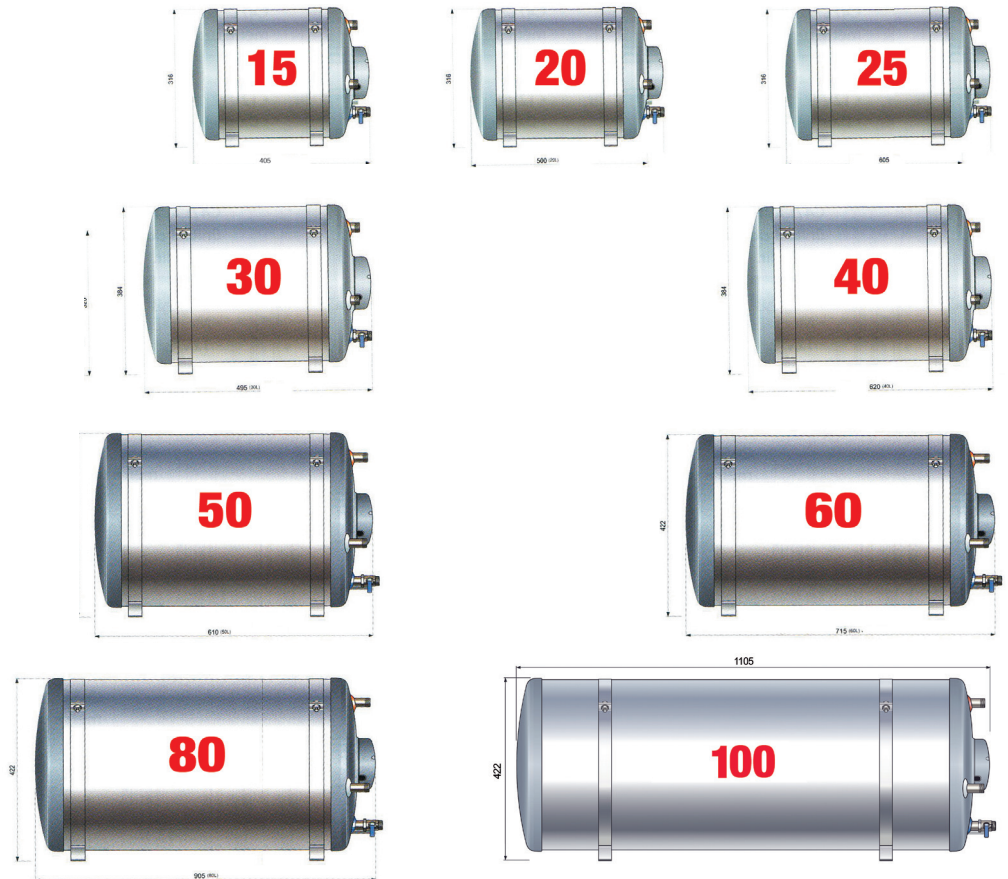
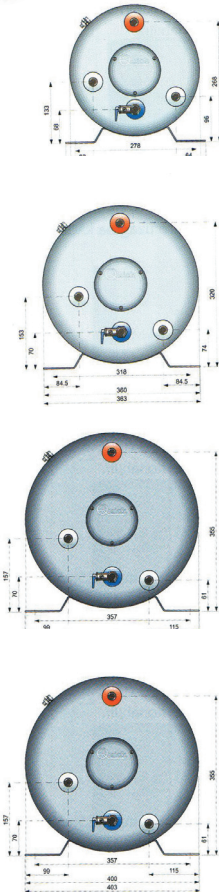

NAUTIC BOILER BX (CASING STAINLESS)

Tank capacity lt	Tank capacity gal.	Electric element voltage	Electric element power	Exchanger	Tank pressure (test)	Max power	Outputs diameter	Dimensions mm	Weight Kg	Code
15	3,9	220 V	1200 W	Yes	8 bar	6 bar	Ø 1/2"	Ø 300 x 405	9,5	RE 88070
20	5,3	220 V	1200 W	Yes	8 bar	6 bar	Ø 1/2"	Ø 300 x 500	10,9	RE 88071
25	6,6	220 V	1200 W	Yes	8 bar	6 bar	Ø 1/2"	Ø 300 x 605	12,3	RE 88072
30	7,9	220 V	1200 W	Yes	8 bar	6 bar	Ø 1/2"	Ø 360 x 495	12,6	RE 88074
40	10,5	220 V	1200 W	Yes	8 bar	6 bar	Ø 1/2"	Ø 360 x 620	14,7	RE 88075
50	13,2	220 V	1200 W	Yes	8 bar	6 bar	Ø 1/2"	Ø 400 x 610	17,0	RE 88077
60	15,8	220 V	1200 W	Yes	8 bar	6 bar	Ø 1/2"	Ø 400 x 715	19,0	RE 88078
80	21,1	220 V	1200 W	Yes	8 bar	6 bar	Ø 1/2"	Ø 400 x 905	22,7	RE 88079
100	26,4	220 V	1200 W	Yes	8 bar	6 bar	Ø 1/2"	Ø 400 x 1105	26,4	RE 88081



NAUTIC BOILER B3 (CASING IN COMPOSITE MATERIAL)

The special composite material of the coating guarantees high-resistance to impact and marine corrosion and it allows a high anageability during installation. The tank is made of 1,5mm gauge 316 Aisi stainless steel. The electrical heating element is made of incoloy steel resistant to galvanic corrosion. Heat exchanger with wide exchange surface.

NAUTIC BOILER

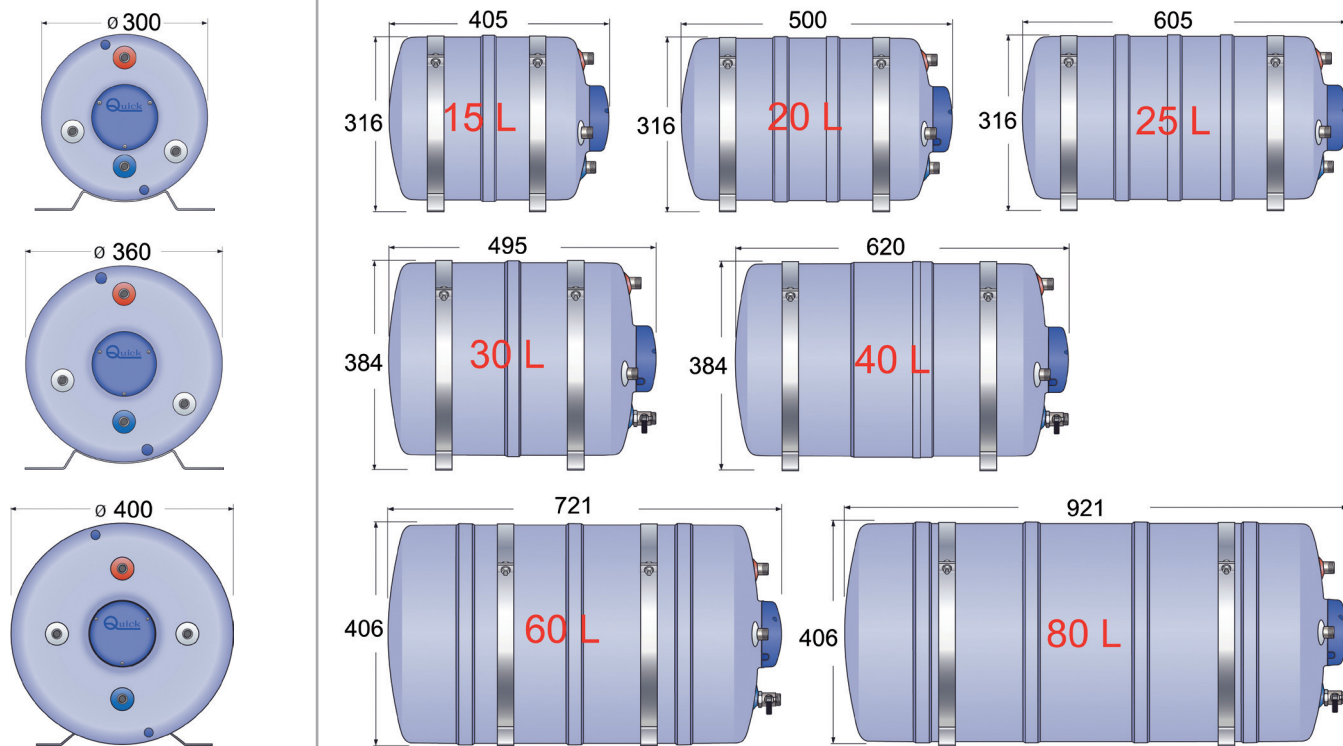

Tank capacity lt	Tank capacity gal.	Electric element voltage	Electric element power	Exchanger	Tank pressure (test)	Max power	Outputs diameter	Dimensions mm	Weight Kg	Code
15	3,9	220 V	1200 W	Yes	8 bar	6 bar	Ø 1/2"	Ø 300 x 405	7	RE 88085
20	5,3	220 V	1200 W	Yes	8 bar	6 bar	Ø 1/2"	Ø 300 x 500	8,1	RE 88086
25	6,6	220 V	1200 W	Yes	8 bar	6 bar	Ø 1/2"	Ø 300 x 605	8,5	RE 88087
30	7,9	220 V	1200 W	Yes	8 bar	6 bar	Ø 1/2"	Ø 360 x 495	10,5	RE 88088
40	10,5	220 V	1200 W	Yes	8 bar	6 bar	Ø 1/2"	Ø 360 x 620	11,7	RE 88089
60	15,8	220 V	1200 W	Yes	8 bar	6 bar	Ø 1/2"	Ø 400 x 721	14,6	RE 88093
80	21,1	220 V	1200 W	Yes	8 bar	6 bar	Ø 1/2"	Ø 400 x 921	17,8	RE 88094

BOILER ABER MARINE

The new Aber Marine water heaters are made of AISI 316 stainless steel, is thermally insulated with high-density polyurethane foam, and protected by a case with integrated mounting brackets. There are two models: the first is lined with shock-proof plastic, the second are equipped with an AISI 316 stainless steel central section. Aber Marine water heaters guarantee high resistance and durability, as they are made with quality materials, suitable for the marine environment.

STANDARD VERSION



Capacity Vac lt	Capacity Vac gallons	Voltage element V	Power W	Dimensions mm	Weight kg	Code
20	5,3	220	1200	366x430x358	7	RE 88124
22	5,8	220	1200	287x558x297	8	RE 88125
30	7,9	220	1200	366x540x358	9	RE 88126
40	10,5	220	1200	366x660x358	11	RE 88127

STAINLESS STEEL VERSION



Capacity Vac lt	Capacity Vac gallons	Voltage element V	Power W	Dimensions mm	Weight kg	Code
30	7,9	220	1200	366x540x358	9,5	RE 88120
40	10,5	220	1200	366x660x358	11,5	RE 88121
60	15,8	220	1200	366x875x358	15	RE 88122
80	21,1	220	1200	417x955x410	22	RE 88123



NAUTIC BOILER BXS (SQUARE)

Made entirely in stainless steel.
 Tank in 316 Aisi stainless steel, casing in 304 Aisi stainless steel.
 Square-shape design for particularly easy installation.
 The thermal insulation is high density polyurethane foam.
 The electrical heating element is made of incoloy with adjustable safety thermostat. Heat exchanger with wide exchange surface.
 Provided with relief/non return valve that allows discharging of the water in case of disuse.
 Included adjustable safety thermostat.

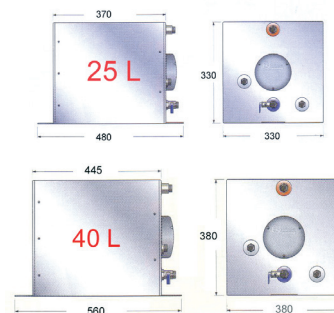

Tank capacity	Tank capacity gal	Electric element voltage	Electric element power	Exchanger	Tank pressure (test)	Max power	Outputs diameter	Dimensions	Weight Kg	Code
25 lt	6,6	220 V	1200 W	Yes	8 bar	6 bar	Ø 1/2"	330x330x480	13,5	RE 88068
40 lt	10,56	220 V	1200 W	Yes	8 bar	6 bar	Ø 1/2"	380x380x560	17	RE 88069



RECTANGULAR NAUTIC BOILER BX

PLACEMENT ANYWHERE
 Two model: with or without heat exchanger
 Compact dimensions and tank in 316 stainless steel
 Easy to install and highly functional
 On request it is available with the heat exchanger only (without electric element)
 Included adjustable safety thermostat

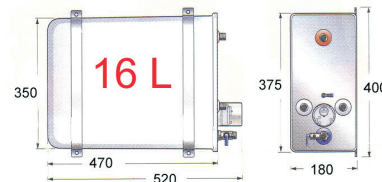

Tank capacity	Tank capacity gal	Electric element voltage	Electric element power	Exchanger	Tank pressure (test)	Max power	Outputs diameter	Dimensions mm	Weight Kg	Code
16 lt	4,22	220 V	1200 W	Yes	8 bar	6 bar	Ø 1/2"	520x350x180	10,5	RE 88031

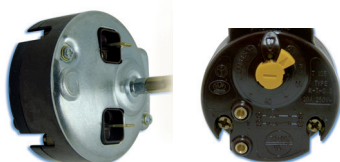

THERMOSTAT

Special adjustable safety thermostat with hand-rearmament
 Setting with a 60° temperature
 Possible to adjustable from 40° to 80°C

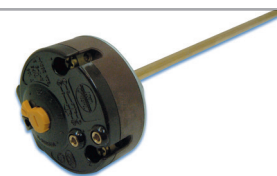

Thermostat

RE 88084

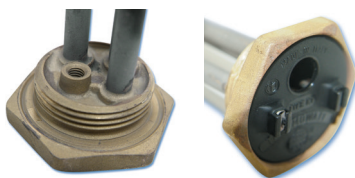

ELECTRIC ELEMENTS

The flange have a 1/4" thread
 Made of incoloy steel
 Resistant to corrosive agent

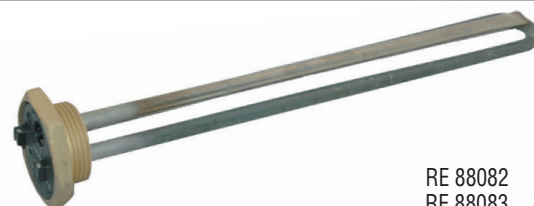

Electric element for stainless steel (220V-1200W)
 Electric element for stainless steel (115V-1200W)

RE 88082
 RE 88083



WATER MIXING VALVE KIT

It recommend installed in all boiler
 Advantages: it increases the autonomy of the water heater
 It avoids accidental burn, so children are safe
 Hot water pipes cannot be broken



Kit includes: thermostatic mixer, T junction, nipples, flexible connection.
 Ready to be installed on each water heater by Quick.

RE 88080

STAINLESS STEEL BOILERS

BOILER GIANNESCHI

Boiler in AISI 316 stainless steel
 Insulation: mineral wool
 Supply with resistance with safety thermostat
 Available in horizontal or vertical version,
 Or with 5Kw resistance (on request)
 Non return valve install on cold water entry

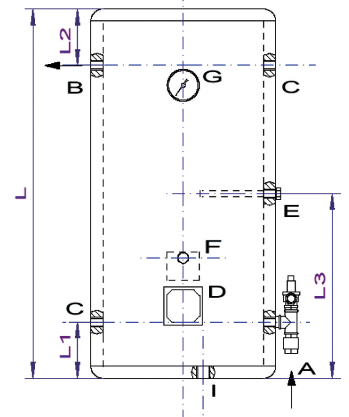
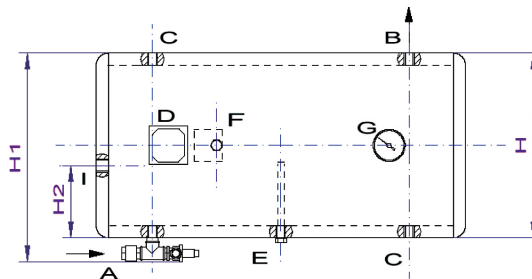
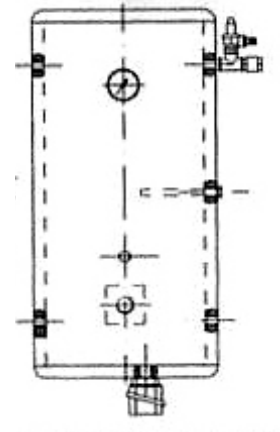
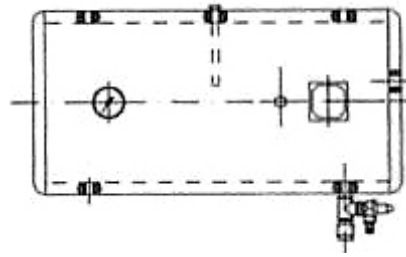

Model	Capacity Vac	Voltage element	Power	Orientation	Case	Tank	Dimensions mm	Weight	Code
25B100	100 lt	230 V	1,5 Kw	Vertical/horizontal	AISI 304	AISI 316	Ø 460 x 920	46 Kg	RE 88110
25B100T	100 lt	230/400 V	3 Kw	Vertical/horizontal	AISI 304	AISI 316	Ø 460 x 920	46 Kg	RE 88111
25B120	120 lt	230 V	1,5 Kw	Vertical/horizontal	AISI 304	AISI 316	Ø 460 x 1120	68 Kg	RE 88112
25B120T	120 lt	230/400 V	3 Kw	Vertical/horizontal	AISI 304	AISI 316	Ø 460 x 1120	68 Kg	RE 88113
03BOL150OR	150 lt	230/400 V	3 + 3 Kw	Horizontal	AISI 304	AISI 316	Ø 510 x 1000	46 Kg	RE 88114
03BOL200VE	200 lt	230/400 V	3 + 3 Kw	Vertical	AISI 304	AISI 316	Ø 510 x 1200	68 Kg	RE 88115



NANO

Extra low profile marine toilet.

- Quiet and fast flush cycle.
- Self contained and easy to install.
- No need of replacing seals or gaskets.
- Low water and electricity consumption.
- Super powerful macerator turbine technology (MAC4).



Voltage	Type Macerator	Water consumption	Ø Diameter drain pipe	Dimensions mm	Weight Kg	Code
12 V	Mac 4	0,5/2 lt	38,5 mm	295x370x446	12,6	RE 86232
24 V	Mac 4	0,5/2 lt	38,5 mm	295x370x446	12,6	RE 86233



COMPASS

The narrow footprint and smart back of the Compass toilet gives maximum space and maximum flexibility wherever it is installed on board.

- Quiet and fast flush cycle.
- Self contained and easy to install.
- No need of replacing seals or gaskets.
- Low water and electricity consumption.
- Both Compass high and short version are equipped with an innovative soft closing system
- Super powerful macerator turbine technology.

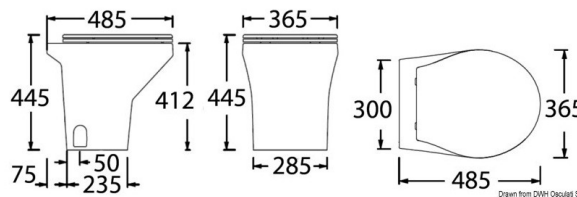

COMPASS STANDARD

Voltage	Type Macerator	Water consumption	Ø Diameter drain pipe	Dimensions mm	Weight Kg	Code
12 V	Mac 4	0,5/2 lt	38,5 mm	445x365x485	21,5	RE 86234
24 V	Mac 4	0,5/2 lt	38,5 mm	445x365x485	21,5	RE 86235



COMPASS SHORT

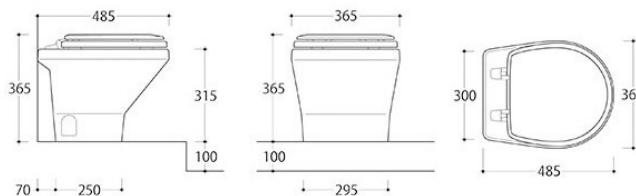

Voltage	Type Macerator	Water consumption	Ø Diameter drain pipe	Dimensions mm	Weight Kg	Code
12 V	Mac 4	0,5/2 lt	38,5 mm	365x365x485	19,5	RE 86236
24 V	Mac 4	0,5/2 lt	38,5 mm	365x365x485	19,5	RE 86237



SILENCE PLUS 2G

W.C. electric SINGLE system (pump) or CENTRALIZED (electrovalve).
 Absolute silent operation (special patented macerator).
 Completely automatic washing cycle, control panel with 2 switches
 • Integrated air admittance valve
 • Easy to install

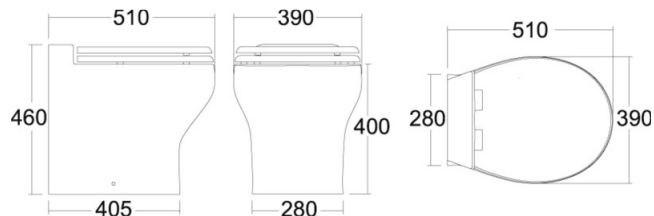

Supply V	System	Absorption	Consumption	Ø Drain pipe mm	Base mm	Dimensions mm	Code
12	Single	3,6	0,5 - 2,7 lt	40	280x405	510x390x460	RE 86238
24	Single	1,8	0,5 - 2,7 lt	40	280x405	510x390x460	RE 86239
12	Centralized	6,6	0,5 - 2,7 lt	40	280x405	510x390x460	RE 86238/C
24	Centralized	3,3	0,5 - 2,7 lt	40	280x405	510x390x460	RE 86239/C

BIDET SILENCE PLUS

RE 86240

Dimensions 510x390x400mm
 Base 280x390mm
 Weight 16Kg

SILENCE PLUS 2G SHORT

W.C. electric SINGLE system (pump) or CENTRALIZED (electrovalve).
 Absolute silent operation (special patented macerator).
 Completely automatic washing cycle, control panel with 2 switches
 • Integrated air admittance valve
 • Easy to install

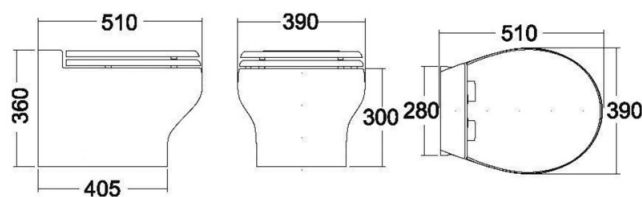

Supply V	System	Absorption	Consumption	Ø Drain pipe mm	Base mm	Dimensions mm	Code
12	Single	3,6	0,5 - 2,7 lt	40	280x405	510x360x405	RE 86241
24	Single	1,8	0,5 - 2,7 lt	40	280x405	510x360x405	RE 86242
12	Centralized	6,6	0,5 - 2,7 lt	40	280x405	510x360x405	RE 86241/C
24	Centralized	3,3	0,5 - 2,7 lt	40	280x405	510x360x405	RE 86242/C

BIDET SILENCE PLUS SHORT

RE 86243

Dimensions 510x390x300mm
 Base 280x390mm
 Weight 14Kg





ELEGANCE 2G

W.C. electric SINGLE system (pump) or CENTRALIZED (electrovalve).
 Absolute silent operation (special patented macerator).
 Completely automatic washing cycle,
 control panel with 2 switches

- Integrated air admittance valve
- Easy to install

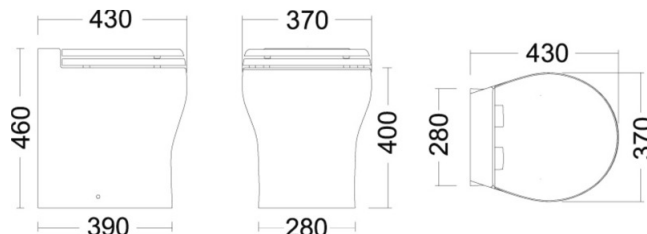

Supply V	System	Absorption	Consumption	Ø Drain pipe mm	Base mm	Dimensions mm	Code
12	Single	3,6	0,5 - 2,7 lt	40	285x380	430x370x460	RE 86244
24	Single	1,8	0,5 - 2,7 lt	40	285x380	430x370x460	RE 86245
12	Centralized	6,6	0,5 - 2,7 lt	40	285x380	430x370x460	RE 86244/C
24	Centralized	3,3	0,5 - 2,7 lt	40	285x380	430x370x460	RE 86245/C

BIDET ELEGANCE

Dimensions 430x370x400mm
 Base 280x370mm
 Weight 13Kg

RE 86246



ELEGANCE 2G SHORT

W.C. electric SINGLE system (pump) or CENTRALIZED (electrovalve).
 Absolute silent operation (special patented macerator).
 Completely automatic washing cycle,
 control panel with 2 switches

- Integrated air admittance valve
- Easy to install

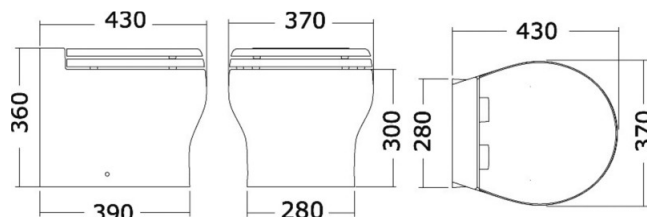

Supply V	System	Absorption	Consumption	Ø Drain pipe mm	Base mm	Dimensions mm	Code
12	Single	3,6	0,5 - 2,7 lt	40	280x370	430x370x360	RE 86247
24	Single	1,8	0,5 - 2,7 lt	40	280x370	430x370x360	RE 86248
12	Centralized	6,6	0,5 - 2,7 lt	40	280x370	430x370x360	RE 86247/C
24	Centralized	3,3	0,5 - 2,7 lt	40	280x370	430x370x360	RE 86248/C

BIDET ELEGANCE SHORT

Dimensions 430x370x300mm
 Base 280x370mm
 Weight 11Kg

RE 86249



All control panels have a tank monitoring led and water amount trim.

ALL IN ONE SFT. The All-in-one control panel has a controller directly integrated in the wall interface with the option of automatic bowl refill (single button) or the common double function before/after use.

PANEL WITH 1 BUTTON

The drain is activated by the “after use” button. After every flush the toilet bowl is automatically refilled with a certain quantity of water, ready for next use.

RE 86258

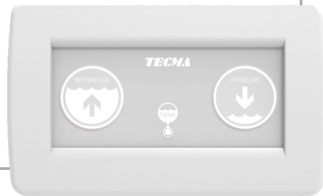

PANEL WITH 2 BUTTON

The drain is activated by 2 buttons “Before use” and “After use” and sailing mode. After every flush the toilet bowl remains empty for navigation.

RE 86259



SFT TOUCH MULTIFUNCTION PANEL

Ultimate touch control panel made of hi-tech tempered glass and LED back lighting with Smart Flush Technology: mooring and sailing mode, water amount trim, overflow protection and tank monitoring.

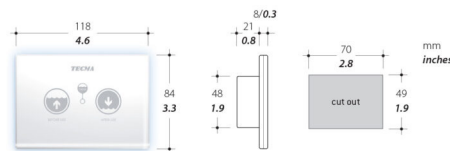

RE 86292



ECO ROCKER SWITCH

Easy to use, sturdy and durable manual activation switch. Reduced consumption of water and energy. To be used with compact series.

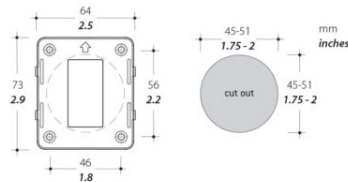

RE 86293

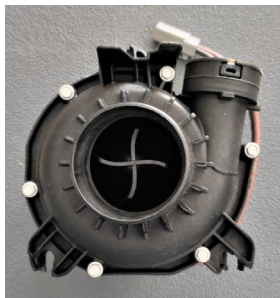

MACERATOR

- Easier waste transfer and no clogging as the cutting blades emulsify all waste
- Macerator chamber before the impeller for optimal grinding
- Silent in operation • Integrated in the ceramic toilet.

MAC MODEL 4

Supply	Absorption	Prevalence	Flow	Code
12V DC	30 A	4 M	130 lt/h	RE 86294
24V DC	20 A	4,5 M	140 lt/h	RE 86295

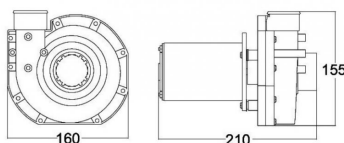

MAC MODEL 11

Supply	Absorption	Prevalence	Flow	Code
12V DC	30 A	4 M	130 lt/min.	RE 86296
24V DC	20 A	4,5 M	140 lt/min.	RE 86297
230V DC	5 A	11 M	270 lt/min.	RE 86298

GRAY WATER TRANSFER SYSTEMS

With a grey water system you create more flexibility and convenience on board. It allows you to install more sanitary appliances like a washbasin, a bidet, a shower, a dishwasher, a washing machine, on board. The grey water system grinds and pumps it to the collection tank.

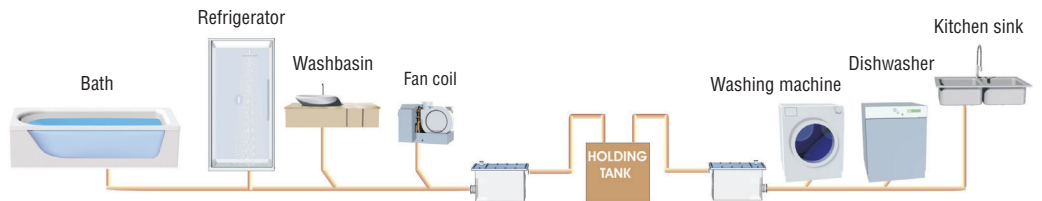

SANISPLIT NK ABOVE SEALEVEL

Patented split system • Efficient strong macerating pump • Silent operation: the silent pump operation combined with the internal rubber tank reduce the sound level • Easy to service: the removable part of the Sanisplit, containing the pump and the pressure switch, can be rapidly disengaged from the fixed parts.

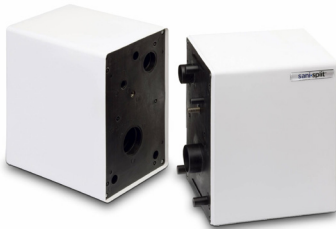

Voltage supply	Abs A	Ø internal pipe inlet	Capacity (lt/min)	Protection class	Max elev head (mt)	Dimensions mm	Weight Kg	Code
12	40	40	270	IP67	11	470x175x270	8	RE 86084
24	30	40	270	IP67	11	470x175x270	8	RE 86085
230	5	40	270	IP67	11	470x175x270	8	RE 86086



SANISPLIT NKS BELOW SEALEVEL

- Stainless steel submersible Sanisplit
- Submersible waterproof system: fully IP67 certified
 - Stainless steel housing
 - Proven macerator technology of Sanisplit NK
 - Silent operation: the silent pump operation combined with the internal rubber tank reduce the sound level
 - Easy to service: once detached any service operation is easily possible without disconnecting the hoses

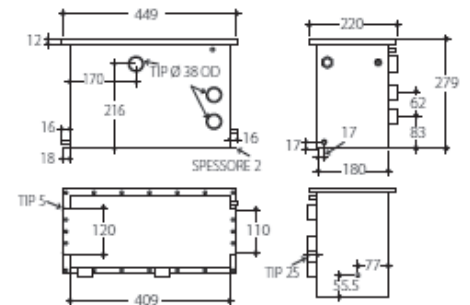

Voltage supply	Abs A	Ø internal pipe inlet	Capacity (lt/min)	Protection class	Max elev head (mt)	Dimensions mm	Weight Kg	Code
12	40	40	2770	IP67	10	449x220x279h	13,7	RE 86226
24	30	40	2770	IP67	10	449x220x279h	13,7	RE 86227
230	5	40	2770	IP67	10	449x220x279h	13,7	RE 86228

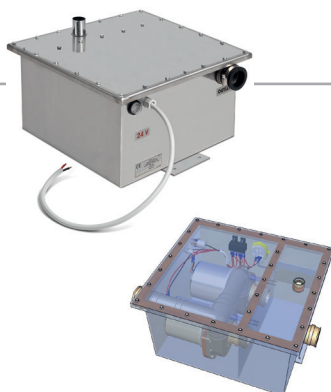

TWIN FOR PARTICULARLY SEVERE USE

Voltage supply	Abs A	Ø internal pipe inlet	Capacity (lt/min)	Protection class	Max elev head (mt)	Dimensions mm	Weight Kg	Code
12	40	40	554	IP67	11	340x350x245	24	RE 86229
24	25	40	554	IP67	11	340x350x245	24	RE 86230
230	3	40	554	IP67	11	340x350x245	24	RE 86231

VISION-IMPACT TOILETS



VISION

Can be installed with a single system (with inlet pump) or centralized system (with electrovalve)
Complete noiselessness of operation (special patented turbine pump)
Completely automatic washing cycle, control panel with 2 switches
Predisposed to discharge in holding tank
White porcelain bowl, seat and cover of wood/polished polyester

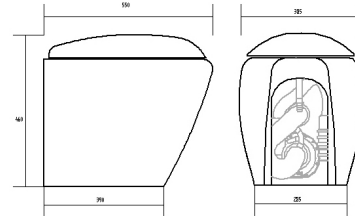

Voltage V	System	Absorption inlet pump	Absorption outlet pump	Ø internal pipe mm	Base mm	Dimensions mm	Code
12	Single	3,6	40	20	285x390	550x385x460	RE 86164
24	Single	1,8	25	20	285x390	550x385x460	RE 86165
12	Centralized	6,6	40	20	285x390	550x385x460	RE 86166
24	Centralized	3,3	25	20	285x390	550x385x460	RE 86167
230	Centralized	0,4	3	20	285x390	550x385x460	RE 86178

BIDET VISION

Dimensions 550x385x415mm
Base 285x390mm

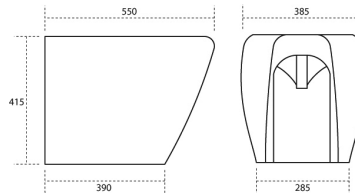

RE 86215



IMPACT

Can be installed with a single system (with inlet pump) or centralized system (with electrovalve). Complete noiselessness of operation (special patented turbine pump).
Completely automatic washing cycle, control panel with 2 switches.
Predisposed to discharge in holding tank.
White porcelain bowl, seat and cover of wood/polished polyester.

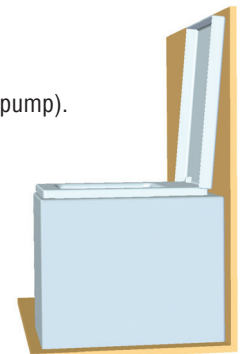
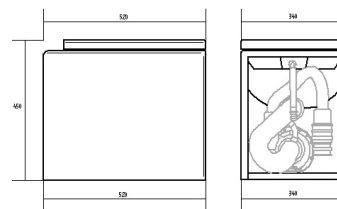

Voltage V	System	Absorption inlet pump	Absorption outlet pump	Ø internal pipe mm	Base mm	Dimensions mm	Code
12	Single	3,6	40	20	340x520	520x450	RE 86200
24	Single	1,8	25	20	340x520	520x450	RE 86201
12	Centralized	6,6	40	20	340x520	520x450	RE 86202
24	Centralized	3,3	25	20	340x520	520x450	RE 86203
230	Centralized	0,4	3	20	340x520	520x450	RE 86204

BIDET IMPACT

Dimensions 520x340x415mm
Base 340x520mm

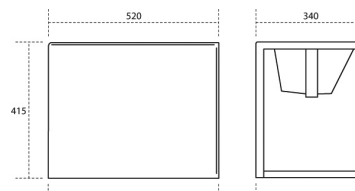

RE 86216

RACE-SKY TOILETS

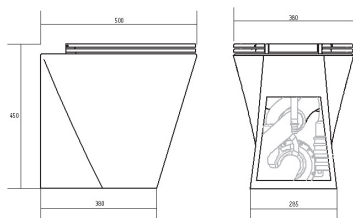

RACE

Created high performances sailing boats
Created for regatta sailing boat. Can be installed with a single system (with inlet pump) or centralized system (with electrovalve)
Absolute noiselessness of operation (special patented turbine pump)
Completely automatic washing cycle, control panel with 2 switches
Predisposed to discharge in holding tank

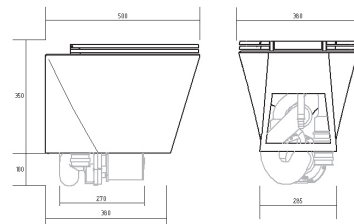

RACE

Voltage V	System	Absorption inlet pump	Absorption outlet pump	Ø internal pipe mm	Base mm	Dimensions mm	Code
12	Single	3,6	40	20	285x380	500x380x450	RE 86082
24	Single	1,8	25	20	285x380	500x380x450	RE 86083
12	Centralized	6,6	40	20	285x380	500x380x450	RE 86082/C
24	Centralized	3,3	25	20	285x380	500x380x450	RE 86083/C

RACE SHORT

Voltage V	System	Absorption inlet pump	Absorption outlet pump	Ø internal pipe mm	Base mm	Dimensions mm	Code
12	Single	3,6	40	20	285x380	500x380x450	RE 86205
24	Single	1,8	25	20	285x380	500x380x450	RE 86206
12	Centralized	6,6	40	20	285x380	500x380x450	RE 86207
24	Centralized	3,3	25	20	285x380	500x380x450	RE 86208

BIDET RACE

Dimensions 500x380x400mm
Base 285x380mm

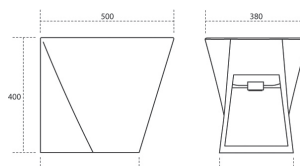

RE 86218

BIDET RACE SHORT

Dimensions 500x380x300mm
Base 285x380mm

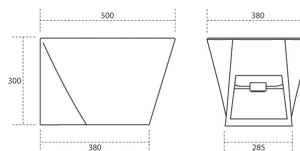

RE 86219

SKY

Wall mounted
Complete noiselessness of operation (special patented turbine pump)
Completely automatic washing cycle, control panel with 2 switches
Predisposed to discharge in holding tank
White porcelain bowl, seat and cover of wood/polished polyester

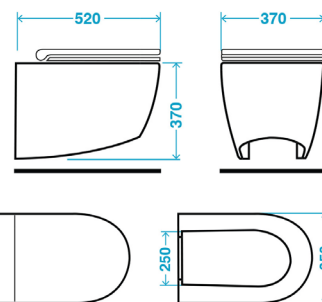

Voltage V	System	Absorption inlet pump	Absorption outlet pump	Ø internal pipe mm	Base mm	Dimensions mm	Code
12	Single	3,6	40	20	280x400	530x380	RE 86080
24	Single	1,8	25	20	280x400	530x380	RE 86081
12	Centralized	6,6	40	20	280x400	530x380	RE 86080/C
24	Centralized	3,3	25	20	280x400	530x380	RE 86081/C

BIDET SKY

Dimensions 560x380x400mm
Base 280x400mm

RE 86217



ARTIC STANDARD

Can be installed with a single system (with inlet pump) or centralized system (with electrovalve)
 Complete noiselessness of operation (special patented turbine pump)
 Completely automatic washing cycle, control panel with 2 switches
 Predisposed to discharge in holding tank
 White porcelain bowl, seat and cover of wood/polished polyester.

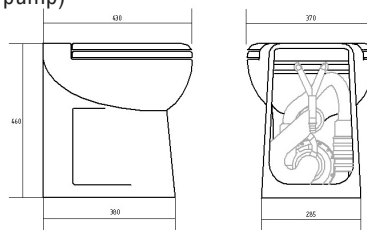

Voltage V	System	Absorption inlet pump	Absorption outlet pump	Ø internal pipe mm	Base mm	Dimensions mm	Code
12	Single	3,6	40	20	285x380	430x370x460	RE 86076
24	Single	1,8	25	20	285x380	430x370x460	RE 86077
12	Centralized	6,6	40	20	285x380	430x370x460	RE 86076/C
24	Centralized	3,3	25	20	285x380	430x370x460	RE 86077/C
230	Centralized	0,4	3	20	285x380	430x370x460	RE 86209

Optional: Kit bidet 12V (to add at the moment of the order)
 Optional: Kit bidet 24V (to add at the moment of the order)

RE 86040
 RE 86041

BIDET ARTIC PLUS

Dimensions 500x380x400mm
 Base 285x415mm

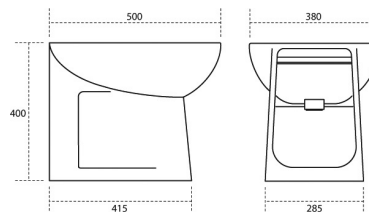

RE 86220



ARTIC SHORT

Can be installed with a single system (with inlet pump) or centralized system (with electrovalve). Complete noiselessness of operation (special patented turbine pump)
 Completely automatic washing cycle, control panel with 2 switches
 Predisposed to discharge in holding tank
 White porcelain bowl, seat and cover of wood/polished polyester.

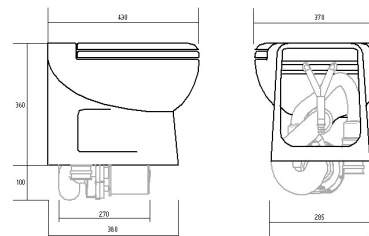

Voltage V	System	Absorption inlet pump	Absorption outlet pump	Ø internal pipe mm	Base mm	Dimensions mm	Code
12	Single	3,6	40	20	285x380	430x370x360	RE 86078
24	Single	1,8	25	20	285x380	430x370x360	RE 86079
12	Centralized	6,6	40	20	285x380	430x370x360	RE 86078/C
24	Centralized	3,3	25	20	285x380	430x370x360	RE 86079/C
230	Centralized	0,4	3	20	285x380	430x370x360	RE 86210

SHORT VERSION: Are manufactured to allow the installation on a step

Optional: Kit bidet 12V (to add at the moment of the order)
 Optional: Kit bidet 24V (to add at the moment of the order)

RE 86040
 RE 86041

BIDET ARTIC PLUS SHORT

Dimensions 500x380x300mm
 Base 285x415mm

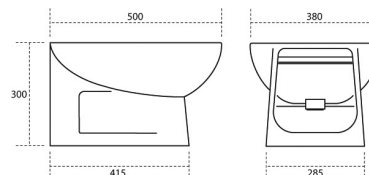

RE 86221



MATCH SHORT

Can be installed with a single system (with inlet pump) or centralized system (with electrovalve). Complete noiselessness of operation (special patented turbine pump) Completely automatic washing cycle, control panel with 2 switches Predisposed to discharge in holding tank Oblique white porcelain bowl, seat and cover of wood/polished polyester.

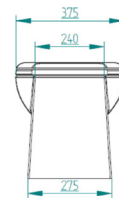
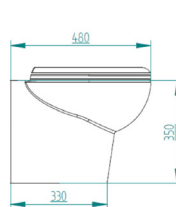

Voltage V	System	Absorption Inlet pump	Absorption Outlet pump	Ø internal pipe mm	Base mm	Dimensions mm	Code
12	Single	3,6	35	40	375x330	480x375x350	RE 86170
24	Single	1,8	25	40	375x330	480x375x350	RE 86171
12	Centralized	6,6	35	40	375x330	480x375x350	RE 86170/C
24	Centralized	3,3	25	40	375x330	480x375x350	RE 86171/C

Optional: Kit bidet 12V (to add at the moment of the order)
 Optional: Kit bidet 24V (to add at the moment of the order)

RE 86040
 RE 86041

BIDET MINI PLUS

Dimensions 500x330x400mm
 Base 290x380mm

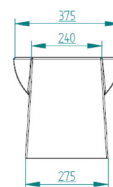
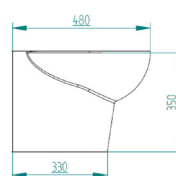

RE 86224

ARTIC SHORT CUT

Can be installed with a single system (with inlet pump) or centralized system (with electrovalve). Absolute noiselessness of operation (special patented turbine pump) Completely automatic washing cycle, control panel with 2 switches Predisposed to discharge in holding tank White porcelain bowl, seat and cover of wood/polished polyester.

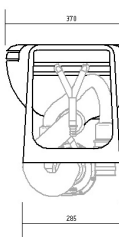
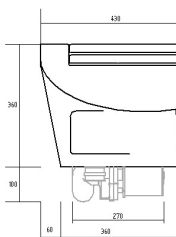

Voltage V	System	Absorption inlet pump	Absorption outlet pump	Ø internal pipe mm	Base mm	Dimensions mm	Code
12	Single	3,6	35	40	285x360	430x370x360	RE 86172
24	Single	1,8	25	40	285x360	430x370x360	RE 86173
12	Centralized	6,6	35	40	285x360	430x370x360	RE 86172/C
24	Centralized	3,3	25	40	285x360	430x370x360	RE 86173/C

SHORT VERSION: Are manufactured to allow the installation on a step

Optional: Kit bidet 12V (to add at the moment of the order)
 Optional: Kit bidet 24V (to add at the moment of the order)

RE 86040
 RE 86041

BIDET MINI SHORT

Dimensions 435x330x330mm
 Base 295x305mm

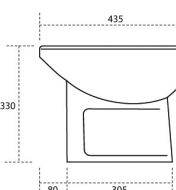

RE 86225





SMART CLASSIC

Can be installed with a single system (with inlet pump) or centralized system (with electrovalve). Complete noiselessness of operation (special patented turbine pump). Completely automatic washing cycle, control panel with 2 switches. Predisposed to discharge in holding tank. White porcelain bowl, seat and cover of wood/polished polyester.

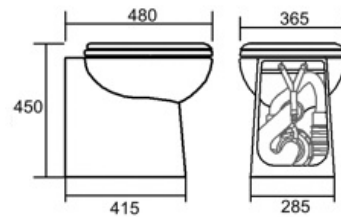

Voltage V	System	Absorption inlet pump	Absorption outlet pump	Ø internal pipe mm	Base mm	Dimensions mm	Code
12	Single	3,6	35	40	285x415	500x365x450	RE 86276
24	Single	1,8	25	40	285x415	500x365x450	RE 86277
12	Centralized	6,6	35	40	285x415	500x365x450	RE 86276/C
24	Centralized	3,3	25	40	285x415	500x365x450	RE 86277/C
230	Centralized	0,4	3	40	285x415	500x365x450	RE 86278

Optional: Kit bidet 12V (to add at the moment of the order)

RE 86040

Optional: Kit bidet 24V (to add at the moment of the order)

RE 86041

BIDET SMART CLASSIC

Dimensions 500X365X410mm
Base 285X415mm

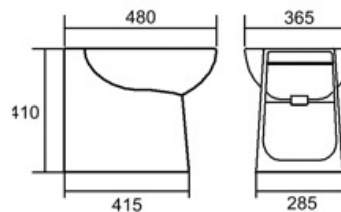

RE 86279



SMART SHORT

Can be installed with a single system (with inlet pump) or centralized system (with electrovalve). Complete noiselessness of operation (special patented turbine pump). Completely automatic washing cycle, control panel with 2 switches. Predisposed to discharge in holding tank. White porcelain bowl, seat and cover of wood/polished polyester.

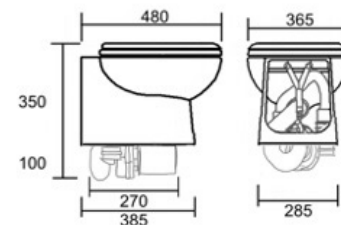

Voltage V	System	Absorption inlet pump	Absorption outlet pump	Ø internal pipe mm	Base mm	Dimensions mm	Code
12	Single	3,6	35	40	285x385	480x365x350	RE 86280
24	Single	1,8	25	40	285x385	480x365x350	RE 86281
12	Centralized	6,6	35	40	285x385	480x365x350	RE 86280/C
24	Centralized	3,3	25	40	285x385	480x365x350	RE 86281/C
230	Centralized	0,4	3	40	285x385	480x365x350	RE 86282

SHORT VERSION: Are manufactured to allow the installation on a step

Optional: Kit bidet 12V (to add at the moment of the order)

RE 86040

Optional: Kit bidet 24V (to add at the moment of the order)

RE 86041

BIDET SMART SHORT

Dimensions 480X365X310mm
Base 385x285mm

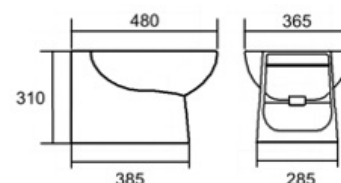

RE 86283



GRINDING SYSTEM

The high speed of rotation of the VORTEX pump and the geometric design of its piping create a great vacuum able to remove water and organic waste from the bowl. The high level of performance ensures the greatest possible flexibility in planning the route of the discharge hoses, allowing it to reach significant distances and heights.

Voltage V	Absorption A	Capacity lt/min	Ø mm connections		Max elev head mt	Code
			Inlet	Outlet		
12	40	277	40	20	9	RE 86068
24	25	277	40	20	9	RE 86069
230	3	277	40	20	9	RE 86073



CONTROL PANEL WITH ONE SWITCH

A part of water remains in the toilette
After using the toilette, press the pushbutton and it starts a complete automatic flushing cycle

Button	Cover color	Installation	Dimensions	Recess hole	Recess depth	Code
1	1 white 1 black	Recess	147,6 x 91,6 mm	110 x 76 mm	46 mm	RE 86062



CONTROL PANEL WITH TWO SWITCHES

The toilette is completely dry when it is in rest position
Pressing "before use" button sends a specific quantity of water into the WC
After using the toilette, pressing "after use" pushbutton starts a completely automatic flushing cycle
Advantage: The toilette is completely dry when in the rest position

Button	Cover color	Installation	Dimensions	Recess hole	Recess depth	Code
2	1 white 1 black	Recess	147,6 x 91,6 mm	110 x 76 mm	46 mm	RE 86070



SLIM PANEL

Reduced depth (1cm)
Compatible with plaques Bticino Living, Vimar Plana, Vimar Eikon

Version: 1 button
2 buttons

RE 86158
RE 86159

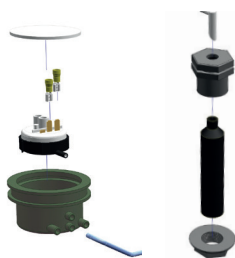

TANK SENSOR

It is a maximum-level sensor
It is activated by air pressure generated by the level of the water
It must be installed in the upper part of the tank with the rubber hose that enters the tank
The pressure switch, located outside the tank, is a normal on-off switch, being electrically connected with the control panel which has a red led that warns the tank is nearly full
Usually the led is green. The sensor may be used to commutate different alarms

RE 86020



KIT PIPE

Kit included two rubber pipes:
N°1 rubber siphon pipe for connection bowl pump
N°1 discharge rubber pipe

RE 86019

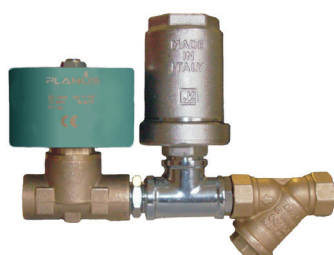

SOLENOID VALVES

The solenoid valves are provided the chiller water hammer.
This device is extremely effective in eliminating the noise and the vibrations that propagate along the pipe water intake.

Version: 12V
24V
230V

RE 86160
RE 86161
RE 86162



STANDARD ELECTRIC TOILETTE

White vitreous china bowl and wooden seat

Compact design

Self priming pump with elastic impeller

High performance macerator

Soft-Close seat

Version	Voltage V	Absorption A	Dimensions mm	Inlet pipe Ø mm	Outlet pipe Ø mm	Weight Kg	Code
Compact	12	17	335x420x390	19	25	11	RE 86001
Compact	24	8	335x420x390	19	25	11	RE 86002
Comfort	12	17	365x460x385	19	25	12	RE 86250
Comfort	24	8	365x460x385	19	25	12	RE 86251
Low	12	17	465x345x315	19	25	10	RE 86252
Low	24	8	465x345x315	19	25	10	RE 86253

LUXURY ELECTRIC TOILETTE

Very comfortable and nice to be seen, just like a home toilette

Stainless steel screws

Brass pump and base anti-crash material

It can be installed either above or below the sea level

High performance pump that allows drainage of waste up to 1,5m

Soft-Close seat

Version	Voltage V	Absorption A	Dimensions mm	Inlet pipe Ø mm	Outlet pipe Ø mm	Weight Kg	Code
Standard	12	30	365x455x455	19	25	22	RE 86071
Standard	24	16	365x455x455	19	25	22	RE 86072
Bevelled	12	26	365x455x455	19	25	22	RE 86254
Bevelled	24	13	365x455x455	19	25	22	RE 86255
Low	12	30	365x455x385	19	25	20	RE 86087
Low	24	15	365x455x385	19	25	20	RE 86088
Low Bevelled	12	26	365x455x385	19	25	21	RE 86256
Low Bevelled	24	13	365x455x385	19	25	21	RE 86257

LAGUNA ELECTRIC TOILET

Base in shockproof material and brass pump

Installable under or over the floating line

High performance pump allows drainage of waste up to 3,5m high

Self priming up to 1,2m

Soft-Close seat

Voltage V	Absorption A	Dimensions mm	Inlet pipe Ø mm	Outlet pipe Ø mm	Weight Kg	Code
12	24	340x405x410	19	25	18	RE 86059
24	12	335x420x390	19	25	18	RE 86060



MANUAL TOILETTE

White china bowl with wooden seat and cover
Easy to charge and discharge
Base and pump in resistant plastic
Soft-Close seat

Version	Dimensions mm	Ø Inlet pipe mm	Ø Outlet pipe mm	Weight Kg	Code
Compact	400x450x340	19	38	9	RE 86003
Comfort	460x470x335	19	38	10	RE 86042
Low	400x450x290	19	38	8	RE 86043



TANK FOR MANUAL WC

Suitable for all marine toilets with compact cup, TMC, Groco, Jabsco, Johnson Pump, Thetford type.

Dimensions: 500x400x230mm

RE 86067



WC COMPACT AND COMFORT KIT MACERATOR

Turn your manual WC in electric
Fastened with 4 bolts, wheelbase 95mm
High performance pump allows drainage of waste up to 5mt high
Interchangeable kit for Jabsco, TMC and Johnson Pump toilet

Voltage V	Ø Inlet mm	Ø Outlet mm	Code
12	19	25	RE 86004
24	19	25	RE 86005

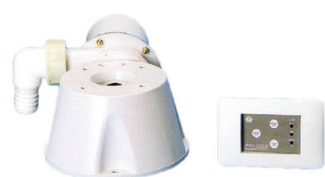

WC COMPACT AND COMFORT KIT VACUUM

Turn your manual WC in electric
Fastened with 4 bolts, wheelbase 95mm

Voltage V	Ø Inlet mm	Ø Outlet mm	Code
12	19	25	RE 86016
24	19	25	RE 86017



SPARE ELECTRO VALVE FOR TOILET

Works at 12/24V

RE 86018

MANUAL PUMP FOR TOILETTE

Pump + base

RE 86006



REPLACEMENT SEAT

When ordering, specify the WC model

RE 86074



Designed in compliance with the new regulations for the discharge of black water in ports.
Equipped with an electronic panel that automatically adjusts the loading and unloading of water.
Very quiet, fully automatic washing cycle.
Very low water consumption (1-2.5 liters).
The drain pump allows you to reach up to 7m in height and 70m in length.
Specify in the order if with solenoid valve or with pump.

STANDARD VACUUM TOILETTE

White porcelain cup with a wooden toilet seat
Compact design and low profile
Soft-Close seat

Version	Voltage V	Absorption A	Dimensions mm	Inlet pipe Ø mm	Outlet pipe Ø mm	Weight Kg	Code
Compact	12	17	335x420x390	19	25	10	RE 86260
Compact	24	8	335x420x390	19	25	10	RE 86261
Comfort	12	17	365x460x385	19	25	11	RE 86262
Comfort	24	8	365x460x385	19	25	11	RE 86263



LUXURY VACUUM TOILETTE

Very comfortable and nice to be seen, just like a home toilette
Stainless steel screws
Brass pump and base anti-crash material
It can be installed either above or below the sea level
Soft-Close seat

Version	Voltage V	Absorption A	Dimensions mm	Inlet pipe Ø mm	Outlet pipe Ø mm	Weight Kg	Code
Standard	12	30	365x455x455	19	25	21	RE 86264
Standard	24	16	365x455x455	19	25	21	RE 86265
Low	12	30	365x455x385	19	25	20	RE 86266
Low	24	16	365x455x385	19	25	20	RE 86267



LAGUNA VACUUM TOILET

Based in protective material and brass pump
It can be installed both above and below the waterline
Soft-Close seat

Voltage V	Absorption A	Dimensions mm	Inlet pipe Ø mm	Outlet pipe Ø mm	Weight Kg	Code
12	19	340x405x410	19	25	18	RE 86268
24	10	335x420x390	19	25	18	RE 86269



LITE FLUSH

A new electric toilette designed to instantly retro-fit your existing manual. Toilette or to give your bathroom a modern stylist look. The innovative design offers both low power and water consumption with an integral rinse and waste pump system. Lightweight and compact. Low water usage-a. 2 litres per flush. Slow close seat and lid. Footswitch operated.

Model	Voltage	Material	Color	Water consumption	Dimensions mm	Weight Kg	Code
Lite Flush	12 V	Plastic	bianco	1,2 lt	407x342x373	-	RE 86025
Lite Flush	24 V	Plastic	bianco	1,2 lt	407x342x373	-	RE 86026



ELECTRIC TOILETS

Compact design with low profile. Easy to use. Self priming pump with elastic impeller. Permanent magnet motor with stainless steel driveshaft. High capacity grinding pump. White china bowl, seat and cover with tough baked enamel coating. Corrosion resistant materials.

Voltage V	Absorption A	Fuse A	Inlet pipe Ø mm	Outlet pipe Ø mm	Weight Kg	Dimensions mm	Code
12	18	25	3/4"	1"	14,5	451 x 352 x 351	RE 86030
24	9	15	3/4"	1"	14,5	451 x 352 x 351	RE 86031

Kits gaskets for electric toilette

RE 86032



MANUAL TOILETS

Compact design with low profile. Powerful swirl action for efficient flushing. Automatic vacuum breaker. Pump and base in cyclac plastic. Reversible pump mounting for choice of right or left handed installation. White china bowl, seat and cover with tough baked enamel coating. Corrosion resistant materials throughout for reliable salt water service.

Inlet pipe Ø mm	Outlet pipe Ø mm	Weight Kg	Dimensions mm	Code
3/4"	1 1/2"	11,6	330 x 440 x 310	RE 86009

Kits gaskets for manual toilette

RE 86033



DELUXE TOILETS

Simple to install. With angled back it is easy to mount against a sloping surface or in a corner. All aspect optimized for minimal water usage and near silent operation. Anti-blocking centrifugal flush pump. Included solenoid valve for connection at centralized system. Supplied with self priming pump to bring in sea to rinse and siphon breaker.

Voltage V	Absorption A	Fuse A	Inlet pipe Ø mm	Outlet pipe Ø mm	Weight Kg	Dimensions mm	Code
12	18	25	3/4"	1"1/2	20	450 x 350 x 445	RE 86168
24	9	15	3/4"	1"1/2	20	450 x 350 x 445	RE 86169

MANUAL PUMP FOR TOILETTE

Can be installed above or below the waterline

RE 86063



ELECTRIC CONVERSION KIT

Vertical kit for manual toilette jabsco. Compatible with compact and regular bowl, left or right hand manual toilets. Existing discharge plumbing remains undisturbed. Simple rotary control knob offers choice of "flush and discharge" or "discharge only". Two powerful self-priming pumps for above or below waterline installation. Dual role macerates waste for both overboard discharge and holding tank. Retains existing jockey valve to maintain automatic back-flow protection.

Voltage V	Absorption A	Fuse A	Inlet pipe Ø mm	Outlet pipe Ø mm	Dimensions mm	Code
12	25	25	19	38	148 x 86 x 266	RE 86027
24	13	15	19	38	148 x 86 x 266	RE 86028



PUMP MACERATOR ABER MARINE

Plastic macerator and rubber impeller discharge pump
 Self priming up to 2mt. vertical lift.
 43 LPM output at 5mt. total head
 Macerates and discharges water and waste mixtures.

Voltage V	Absorption A	Capacity lt/min	Inlet port connections	Outlet port connections	Dimensions mm	Code
12	12	43	38 mm	25 mm	240x130x90	RE 86021
24	6	43	38 mm	25 mm	240x130x90	RE 86023



PUMP MACERATOR

Ideal for evacuating holding tank
 High capacity and high reliability
 Nitrile impeller - Self priming up to 2m vertical lift



Voltage V	Absorption A	Capacity lt/min	Inlet port connections	Outlet port connections	Dimensions mm	Code
12	16	46	1" 1/2	1"	280 x 110 x 80	RE 86064
24	8	46	1" 1/2	1"	281 x 110 x 80	RE 86065



PUMP MACERATOR

Ideal for evacuating holding tank
 High capacity and high reliability - Ignition protected

Voltage V	Absorption A	Capacity lt/min	Inlet port connections	Outlet port connections	Dimensions mm	Code
12	12	43	1" 1/2	1"	240 x 130 x 90	RE 86007
24	7	43	1" 1/2	1"	240 x 130 x 90	RE 86008
12	14	47	1" 1/2	1"	260 x 130 x 90	RE 86045
24	8	47	1" 1/2	1"	260 x 130 x 90	RE 86046



VENTED LOOP JABSCO

Vented loops guard against danger of water siphoning over pipework loops in below the waterline installations of toilets and bilge pump



Vented loop Ø 38mm
 Vented loop Ø 19mm

RE 86034
 RE 86035



VENTED LOOP JABSCO

Vented loops guard against danger of water siphoning over pipework loops in below the waterline installations of toilets and bilge pump

Vented loop Ø 38mm
 Vented loop Ø 25mm
 Vented loop Ø 19mm

RE 86037
 RE 86075
 RE 86038



Y VALVE JABSCO



Two way valve
Allows to be pumped directly overboard or into a holding tank
Allows two bilge sections to be emptied by one pump
Waste and corrosion resistant construction throughout
Rotating discharge ports simplifies installation

N° way	Materials	Weight Kg	Inlet port connections	Outlet port connections	Dimensions mm	Code
3	ABS	0,90	1" 1/2	1" 1/2	194 x 184 x 117	RE 86036



Y VALVE

A new universal strong y valve for use in bilge application
Can be padlocked. ABS body

N° way	Color	Weight Kg	Inlet port connections	Outlet port connections	Dimensions mm	Code
3	White	0,5	1" 1/2	1" 1/2	140 x 150 x 150	RE 86039



Y 2005 VALVE

For use in bilge applications
Standard connections 38mm and extra 25mm
Weight 0,8Kg - Mesures 200x800x60mm

RE 86010



WASTE HOLDING TANK



Waste holding tank with pump, filter and floating switch
5 inputs (19-19-25-28.6-38) and one output at 19 of diameter
Internal check valve for preventing back flow
Removable stainer

Voltage V	Capacity lt/min	Input diameter mm	Output diameter mm	Dimensions mm	Code
12	50	Ø 19 - 25 - 30 - 38	Ø 19	235 x 285 x 130	RE 86022
24	50	Ø 19 - 25 - 30 - 38	Ø 19	235 x 285 x 130	RE 86024



CARBON FILTERS

Made in light-weight metal alloy and nylon
Must be placed in the higher point of the boxes air valve
Carbon must not be in contact with liquid contained in the box

RE 86029

**SINGLE LEVER MIXERS**

Single lever with ceramic valves
Swivelling spout
Max projection: 210mm
Max height: 130mm

RE 86047

**MIXER TAP**

Single lever + extractable shower with
flexible pipe of 1.5mt
Double jet switch
Max projection: 240mm
Max height: 170mm

RE 86048

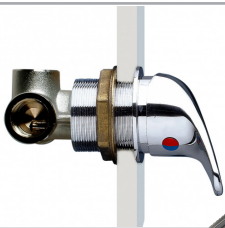
**SINGLE LEVER CERAMIC MIXER**

Single lever chromed brass mixer, perfect for showers
Wall installation with flanges
Height: 110mm
Diameter: 40mm

RE 86049

**MIXER TAP**

In chromed brass
Handwheel movement
Max projection: 210mm
Height: 190mm

RE 86050

**MIXER TAP**

Single lever + extractable shower with
flexible pipe of 1.5mt
Double jet switch
Max height: 170mm

RE 86051

**SHOWER MIXER**

In chromed brass
Complete with inlet case in white ABS
Inlet diameter: 55mm
Max external diameter: 90mm

RE 86052

**MIXER FOR SEPARATED SHOWERS**

Cold/hot mixer in chromed brass
Complete with inlet case in white ABS
Inlet diameter: 55mm
Max external diameter: 90mm

RE 86066

**SHOWER WITH HOSE**

If you push the switch the water flows. If you lift it you obtain a direct jet
Gained support in chromed brass and nylon
Reinforced white hose of 5 meters

RE 86011

**CERAMIC TAPS**

Single brass tap (only cold water)
Lowering and folding pipe
Max height: 210mm
Width: 90mm

RE 86053

**CERAMIC TAPS**

Brass mixer (hot and cold water)
Lowering and folding pipe. For closed sink
Max height: 210mm
Max proj: 240mm

RE 86054

**MIGNON SERIES**

Single Brass (only cold water) with folding spout
Max height: 180mm
Max proj: 180mm

RE 86055

**MIGNON SERIES**

Mixer Brass (hot & cold water) with folding spout
Max height: 140mm
Max proj: 190mm

RE 86056

**LEVER SHOWER**

Gained support in chromed brass and nylon
If you push the switch the water flows
If you lift it you obtain a direct jet
Reinforced white hose of 2 meters
Max height: 140mm

RE 86057

**PUSH-BUTTON SHOWER**

Shower with push button
With inlet case, cover and 2 meters hose
Inlet diameter: 58mm
Max external diameter: 95mm

RE 86058

**TRIGGER SHOWER**

In white ABS with 45° curve in chromed brass
If you push the switch the water flows
If you lift it you obtain a direct jet
Gained support in chromed brass and nylon
Reinforced white hose of 2 meters
Max height: 90mm
Max proj: 130mm

RE 86061

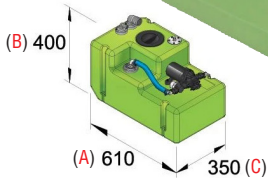

DRINKING WATER TANK

This high-grade synthetic tank for drinking water is supplied with an electric pump which automatically switches on when the pressure in the system drops (for example, when a tap is opened).

The installation of a DWS tank saves valuable time, as only the hoses and power supply have to be connected. The premium drinking water system offers a high degree of usability.

All connections for filling pipe 38mm diameter suction and 16mm diameter ventilation are supplied pre-installed, together with a filter in the suction line and a float sensor to connect a level gauge. An inspection cover enabling the inside of the tank to be cleaned is also fitted as standard.

Model	Capacity	Voltage	Length (A)	Width (C)	Height (B)	Pump capacity lt/min.	Water hose	Venting hose	Filler hose	Code
DWSC04212	42 lt	12V	610 mm	350 mm	400 mm	13,2	Ø12 mm (1/2")	Ø16 mm (5/8")	Ø 38 mm (1 5/8")	RE 86400
DWSC04224	42 lt	24V	610 mm	350 mm	400 mm	13,2	Ø12 mm (1/2")	Ø16 mm (5/8")	Ø 38 mm (1 5/8")	RE 86401
DWSC06112	61 lt	12V	780 mm	350 mm	400 mm	13,2	Ø12 mm (1/2")	Ø16 mm (5/8")	Ø 38 mm (1 5/8")	RE 86402
DWSC06124	61 lt	24V	780 mm	350 mm	400 mm	13,2	Ø12 mm (1/2")	Ø16 mm (5/8")	Ø 38 mm (1 5/8")	RE 86403
DWSC08812	88 lt	12V	930 mm	400 mm	400 mm	13,2	Ø12 mm (1/2")	Ø16 mm (5/8")	Ø 38 mm (1 5/8")	RE 86404
DWSC08824	88 lt	24V	930 mm	400 mm	400 mm	13,2	Ø12 mm (1/2")	Ø16 mm (5/8")	Ø 38 mm (1 5/8")	RE 86405
DWSC12012	120	12V	1050 mm	450 mm	400 mm	13,2	Ø12 mm (1/2")	Ø16 mm (5/8")	Ø 38 mm (1 5/8")	RE 86406
DWSC12024	120	24V	1050 mm	450 mm	400 mm	13,2	Ø12 mm (1/2")	Ø16 mm (5/8")	Ø 38 mm (1 5/8")	RE 86407

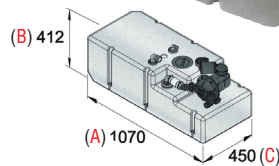
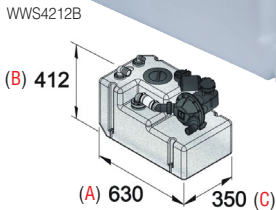

WASTE WATER TANK SYSTEM

The waste water tank system is designed to save on space and installation time.

Is made of odour-impermeable polythene.

It is suitable for storing both 'black' and 'grey' waste water and is provided with ISO 8099 identification.

The "ready to go" system comes complete with a VETUS waste water pump type EMP (12V), an inspection cover, a tank gauge sender (the 12V level gauge must be ordered separately), a plastic suction pipe with 38mm-diameter angled hose connection for discharge from ashore, two securing straps and one 19mm-diameter connection for the breather.

Model	Capacity	Voltage	Dimensions (A) x (C) x (B) mm	Pump capacity lt/min.	Discharge hose	Intake hose	Filling hose	Air relief hose	Code
WWS4212B	42 lt	12V	630x350x412	27	Ø 38 mm (1 1/2")	Ø 38 mm (1 1/2")	Ø 38 mm (1 1/2")	Ø 19 mm (3/4")	RE 86410
WWS4224B	42 lt	24V	630x350x412	27	Ø 38 mm (1 1/2")	Ø 38 mm (1 1/2")	Ø 38 mm (1 1/2")	Ø 19 mm (3/4")	RE 86411
WWS6112B	61 lt	12V	800x350x412	27	Ø 38 mm (1 1/2")	Ø 38 mm (1 1/2")	Ø 25 mm (1")	Ø 19 mm (3/4")	RE 86412
WWS6124B	61 lt	24V	800x350x412	27	Ø 38 mm (1 1/2")	Ø 38 mm (1 1/2")	Ø 25 mm (1")	Ø 19 mm (3/4")	RE 86413
WWS12012B	120 lt	12V	1070x450x412	27	Ø 38 mm (1 1/2")	Ø 38 mm (1 1/2")	Ø 16 mm (5/8")	Ø 19 mm (3/4")	RE 86414
WWS12024B	120 lt	24V	1070x450x412	27	Ø 38 mm (1 1/2")	Ø 38 mm (1 1/2")	Ø 16 mm (5/8")	Ø 19 mm (3/4")	RE 86415